

TOEDESIGN PORTFOLIO UPDATE

Toy design since 1996.

Design & Consultant



Aaron Tompkins
www.Toedesign.com
Toedesign@aol.com







Steven Fink

June 7 at 4:03pm · Cincinnati, OH · 2

In a couple of weeks, Grossery Gang toys will hit the stores! They are from our pals at Moose Toys, the makers of Shopkins, and were invented by Bang Zoom, and my Poughkeepsie Peep Aaron Tompkins . Grossery Gang is a line of mini collectibles for boys, and hopefully girls who love Shopkins will also want em! Here's a vid:



The Grossery Gang meets Shopkins OFFICIAL SNEAK PEEK

Meet the Grossery Gang! The grossest, moldiest collectable in the universe! Browse the vile aisles of putrid products and foul foods! It's your One Slop Shop...

YOUTUBE.COM

Co/Creator of Grossery Gang w/ Bang Zoom Design.

Mini Collectibles



The Grossery Gang™

YOUR SHOPPIN'S GONE ROTTEN!

Co/Creator of Grossery Gang w/ Bang Zoom Design.

Mini Collectibles





Photo credit: Steve Casino





BOO-BOOS + You are the Nurse!

SERIES 01: pet vet

1 FIRST YOU GET YOUR PATIENTS CLIP BOARD.

2 SECOND YOU FIND PATIENT IN NEED.

3 THIRD FIND TINY CASTS & BANDAGES.

4 FORTH FIND HOSPITAL BED.

5 CLIP BOARD TELLS YOU WHAT TO DO!

6 ALL BETTER!

7 COMES WITH COLLECTIBLE BAND AID STICKER REWARD.

OPEN BAND-AID BOX.

YOU HEAL them!

YOU HEAL them!

YOU HEAL them!

YOU CURES him!

YOU HEAL them!



BOO-BOOS + You are the Nurse!

SERIES 01: pet vet

LUCKY

PAND-DUH

BIRDIE

SCRUFF

RUFF

PUFFY

FISHBOWL

JUMPER

YOU HEAL them!

YOU HEAL them!

YOU HEAL them!

YOU HEAL them!

YOU HEAL them!

YOU HEAL them!

BOO-BOOS *BAND AID BOX FOLDS OPEN INTO PET VET.

BAND AID BOX 4.99

NAME: Lucky
Puppy got hurt in the dog show!
Can you heal him?

YOU HEAL them!

*PATIENTS CLIP BOARD WITH INFO ON THERE BOO BOO.

*FLOCKED

Transforms Back and Forth!

INCLUDES: (1) SICK PET + EVERYTHING YOU NEED TO HEAL THEM!







CELL LOCK UP

At the beginning of the game, everyone puts their phone into the cell phone jail.

As time goes on, you'll hear various calls, texts, and emails, but you can't pick up your phone. If you're the first one to give in to temptation, and open the jail an alarm will sound.

cell phone jail



Card game asks very simple questions, players can NOT use these phones for answers EX: Bosses phone number EX: Best friends birthday EX: Boyfriends email



3.If opened before the time is up, the alarm sounds!



PRISON CELL
GET YOUR PHONE FREE!

1 SPIN TO CHOOSE YOUR KEY COLOR.

2 TAKE CARD ANSWER QUESTION

3 TRY KEY IN LOCK. WILL IT OPEN?

4 KEY SEQUENCE OPENS LOCK (NOT ONE SINGLE KEY)

5 USE THE WRONG KEY & THE SIREN WILL SOUND!

Who Will Be The Last Player To Break Their Phone Out of Prison?

NOT FINAL DEVELOPMENT

DESIGN 10.22.18





exclusive!

12 Days of Christmas Elmo

Ages: 18 months & up

\$15.00

If Elmo's your true love, get ready for a wacky 12 days of Christmas! Each time you squeeze his hand, this cuddly elf sings a phrase from his own silly version of the 12 Days of Christmas song. While he sings, the star in his hand lights up and glows. Illustrated song sheet lets you sing and count along, from 12 monsters humming, all the way down to a great big pizza with cheese!

Approx. 13"

1. Press **2. Add Fortune** **3. Fold** **4. Fold Again** **5. Let Dry**

HELLO KITTY

JAKKS Pacific

Includes: 2x Fondant, Cookie Cutter, Rolling Pin, Cookie Folder, marker w/ edible ink, edible pered paper, Fortune Cookie Gift Box!

Flavors: BANANA, BLUEBERRY, CAPPUCCINO, CHERRY, CHOCOLATE, CINNAMON, COCONUT, FRUIT PUNCH, GREEN APPLE, LEMON, MINT, ORANGE, RASPBERRY, RED APPLE, STRAWBERRY

Girl GOURMET Sweet's
Make it. Wear it. Eat it.

Makes Up to 30 CANDY JEWELS!

Includes CANDY!

Create Your Own EDIBLE JEWELRY!

Candy Jewelry Factory

CONTAINS 14 PIECES



HELLO KITTY

HELLO KITTY

HELLO KITTY

HELLO KITTY

STRETCHKINS

HELLO KITTY

STRETCHES FROM 20" UP TO 44"

HELLO KITTY

STRETCHKINS HELLO KITTY

Count Chocula CONTROL ART

03.30.06

sculpt reference

ASSEMBLY
Soft Vinyl Cape

RETRO

FLOCKED HAIR
pantone 1817 u

Matte blk pupil & inside mouth

7423 c tongue

note: inside of hand

Soft Vinyl Cape

Shoulder ball joint

Ball joint head

Ball Shoulder joints

Ball Shoulder joints

SOFT VINYL CAPE

Flocked white

Shoe reference SIDE

8"

plastic pantone 1817 u

wht

pantone 7154 u

Shoe reference SIDE

BACK

ROTO CAST COLLECTOR FIGURE

MANUFACTURER: TOY TOKYO N.Y.C.

FrankenBerry CONTROL ART

03.30.06

DESIGN OBJECTIVE:
Combine "retro" design of classic character with current "urban" style.

Strawberry fingernail sculpted in

7489 u

Pantone 7520 u

pantone 485 u

Fingernail Closeup

3 FINGERS 1 THUMB

Chains are suspenders and go over shoulder and down back.

Head ball joint hole/front

Ball joint shoulders

8.0"

1 THUMB

3 FINGERS

BACK ANGLE

BACK

ROUND CIRCLE BOTTOM

ROUND CIRCLE BOTTOM

ROTO CAST COLLECTOR FIGURE

MANUFACTURER: TOY TOKYO N.Y.C.

Count Chocula SAMPLE APPROVAL

09.05.07

ROTO CAST COLLECTOR FIGURE

MANUFACTURER: TOY TOKYO N.Y.C.

FrankenBerry ROTO CAST COLLECTOR FIGURE

MANUFACTURER: TOY TOKYO N.Y.C. SAMPLE APPROVAL 09.05.07

GET READY TIME

\$9.99

Let's count how many times I brush! 1,2,3,4,5...



Brush to the Beat! Do do do do. Do do do do. Do do do do...



SHAKE ELMO UP AND DOWN TO SEE HIM BRUSH AND HEAR HIM COUNT STROKES.

- HELP ELMO GET READY FOR HIS DAY OR READY FOR BED AS HE BRUSHES HIS TEETH.

- GIVE HIM A SHAKE TO HEAR HIM COUNT, GIVE BRUSHING TIPS OR TIME YOUR BRUSHING WITH A SONG.

- 1-10 COUNTING
- BRUSHING SONG
- NUMBERS SONG
- BRUSHING TIPS & TIMER



Brush to the Beat! Do do do do. Do do do do. Do do do do...

TOOTHBRUSHING TIMER.



WAKE UP TIME

\$9.99



OI, I'M UP. 'ALREADY!'

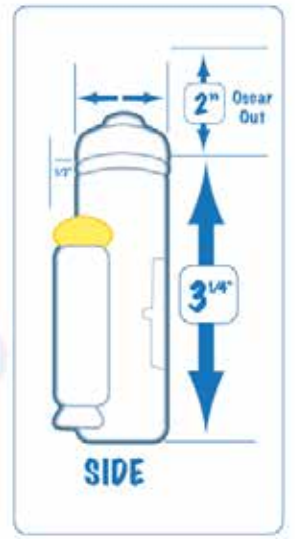

Grouchy in the morning?
Turn the clock dial for number identification and counting. When you hit certain times Oscar pops out wide awake and ready for a horrible day.

- Number Identification
- 1-12 Counting
- Cause and Effect
- Pinching
- Dialing



YOU MAKE EVERYTHING OUTTA BREAD & ICING & SPRINKLES.



MINI WORLD HOT DOG CART

CHILD USES MARKER WITH EDIBLE INK TO DECORATE THE PRESSED BREAD ADDING ICING OR SPRINKLES.

SIZED FOR 9-11" FASHION DOLLS



HOT DOG MOLD CAN BE SWAPPED OUT FOR HAMBURGER MOLD OR GRILLED CHEESE SANDWICH MOLD OR PRETZEL MOLDS.

micro MASH UPS

DESIGN 01 MUSCLE TREDZ

1 MAGNETIC KEY INCLUDED

WAVE IT OVER VEHICLE TO LOCK & UNLOCK THE PARTS.

2 MOTOR POPS OUT WHEN PIECES LOCK

TEENAGE MUTANT NINJA TURTLES ROOFTOP BATTLE!

ACTION GAME

It's the 4 Turtles -vs- the Foot in this Rooftop Action Game!
Use your Turtle shooter to Knock the foot soldiers through your goal!
The player who knocks the most foot soldiers off the roof is the winner!!!

#1 Launch bearing entrapped player pieces. IE "Speedez"

#2 Skill levels vary with adding or subtracting of "Rooftop Bumpers"

#3 Breakaway skylight trap.

#4 Adjustable Launchers.

#5 Storage door.

#6 Player must knock out wall prior to shooting foot soldiers through there goal.

#7 Breakaway Water Tower. (Beware don't hit the legs or the tower, comes crumbling down)

PLAYING PEICES
8 Raph
8 Leo
8 Mike
8 Don
16 Foot
1 Shredder.

(Knock Shredder off the roof for an Automatic win)

Toedesign inc. 2011.toe.0225

NITRO CIRCUS

Concepts for die casts

Helicopter stunt

Boat Launch

Pool Jump

Printed plastic mat

BATTLE MACHINES RC GEL AMMO

•LOAD GEL AMMO.

•PRESSURE SENSITIVE REAR GATE

•SCORE THREE HITS AND ITS VICTORY!

•ROTATE CANNON UP/DOWN

•SHOOT GEL AMMO.

SILVERADO GEL AMMO

Jada TOYS

•RC CONTROLLED.

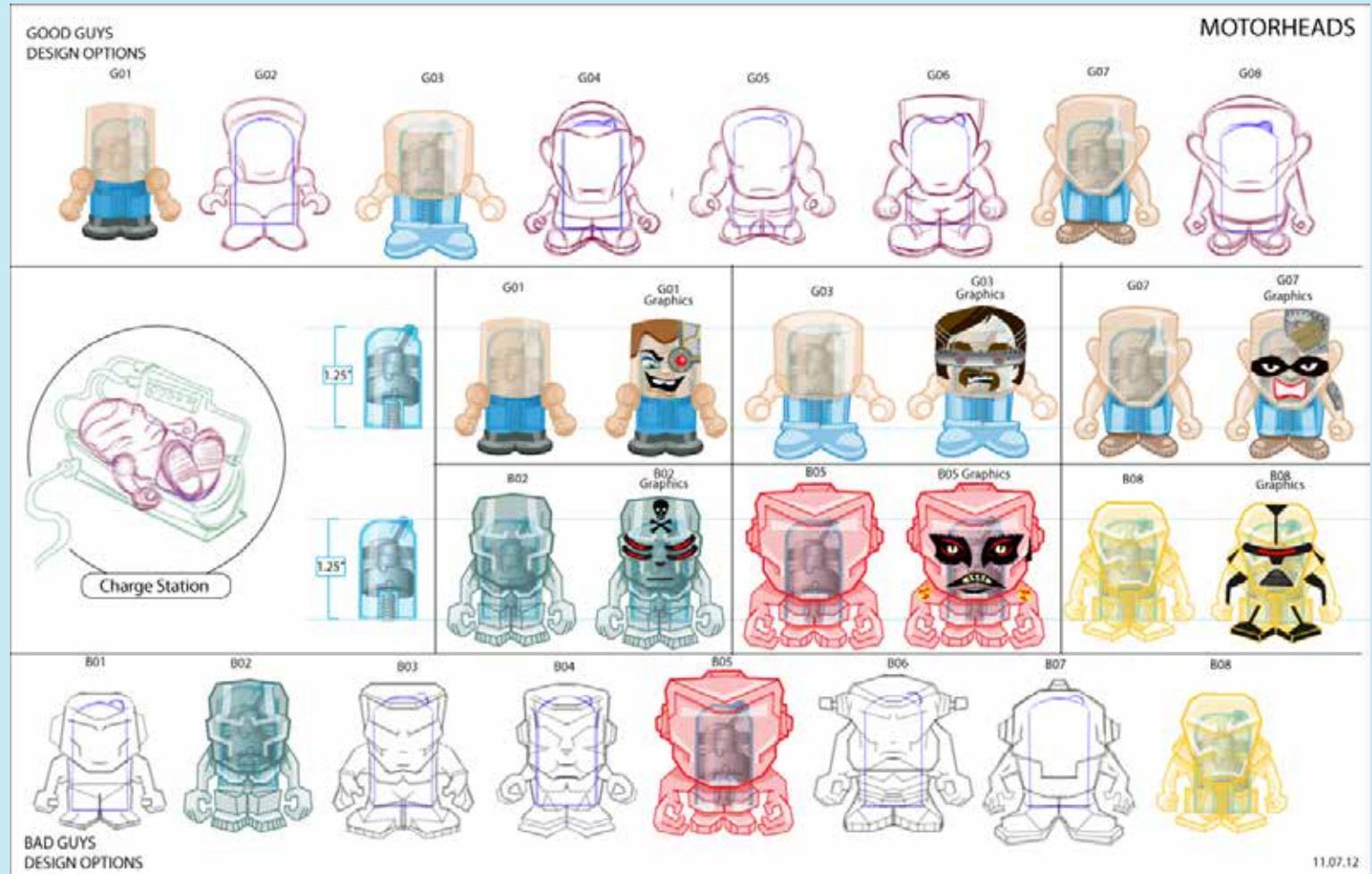
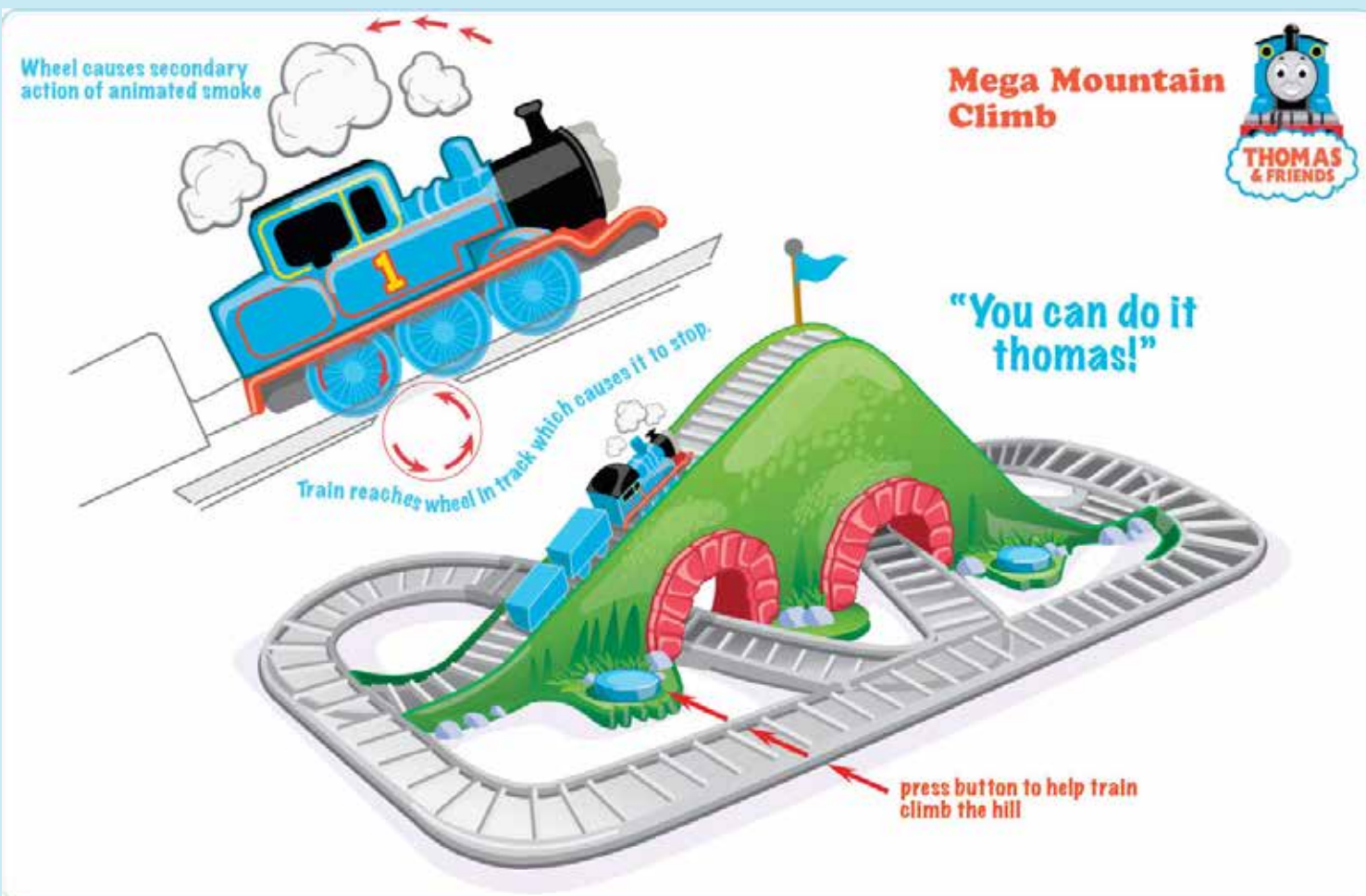
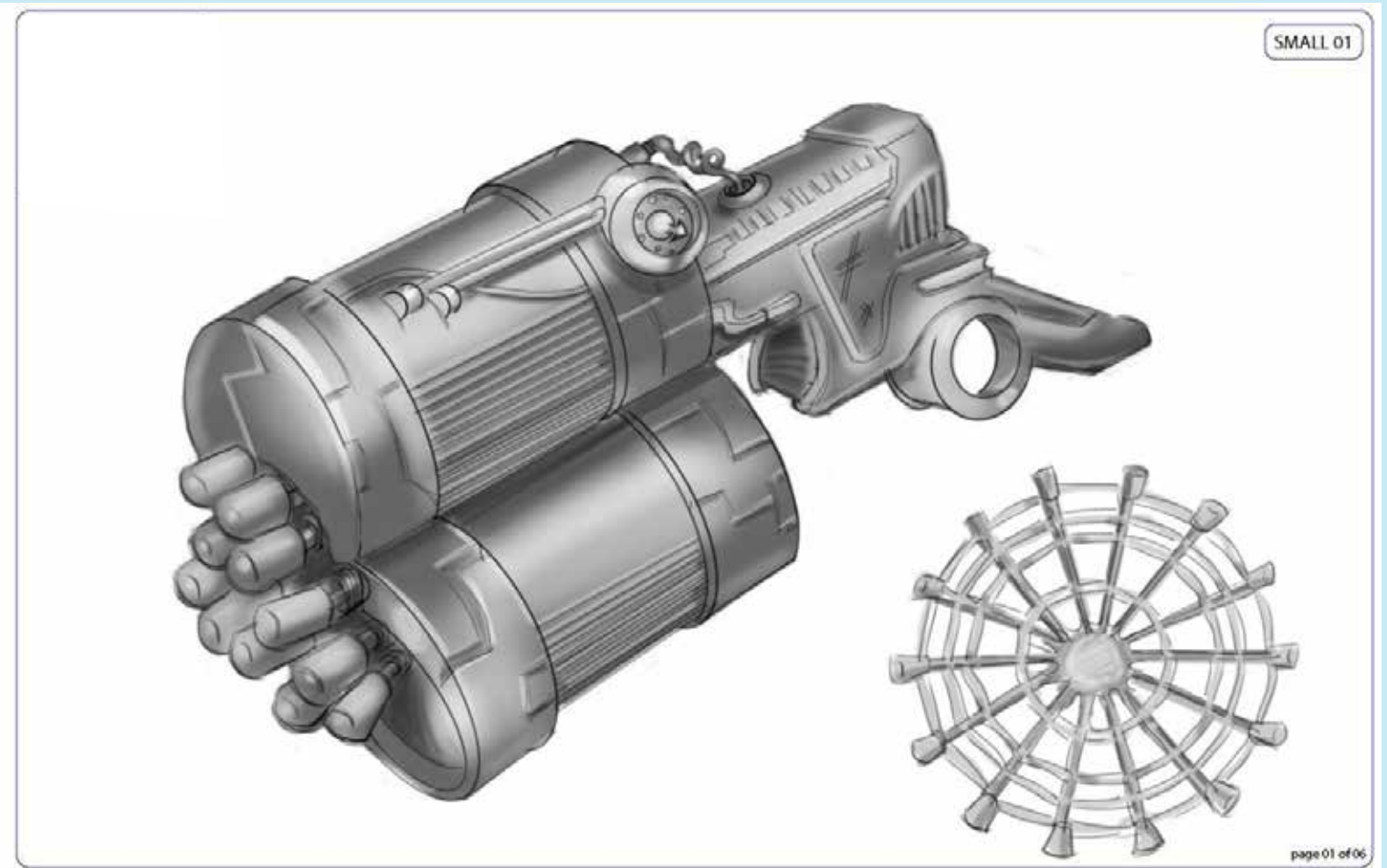

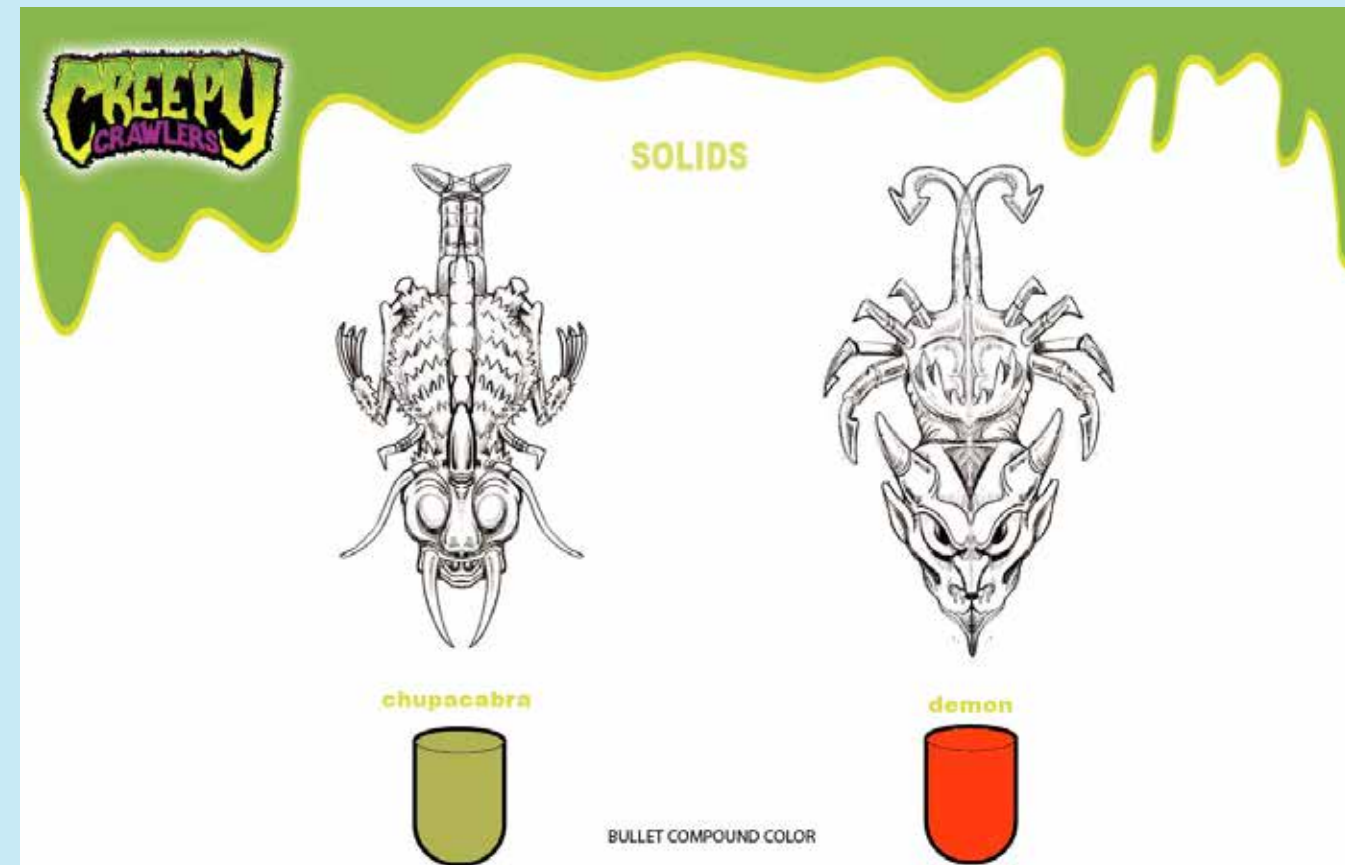
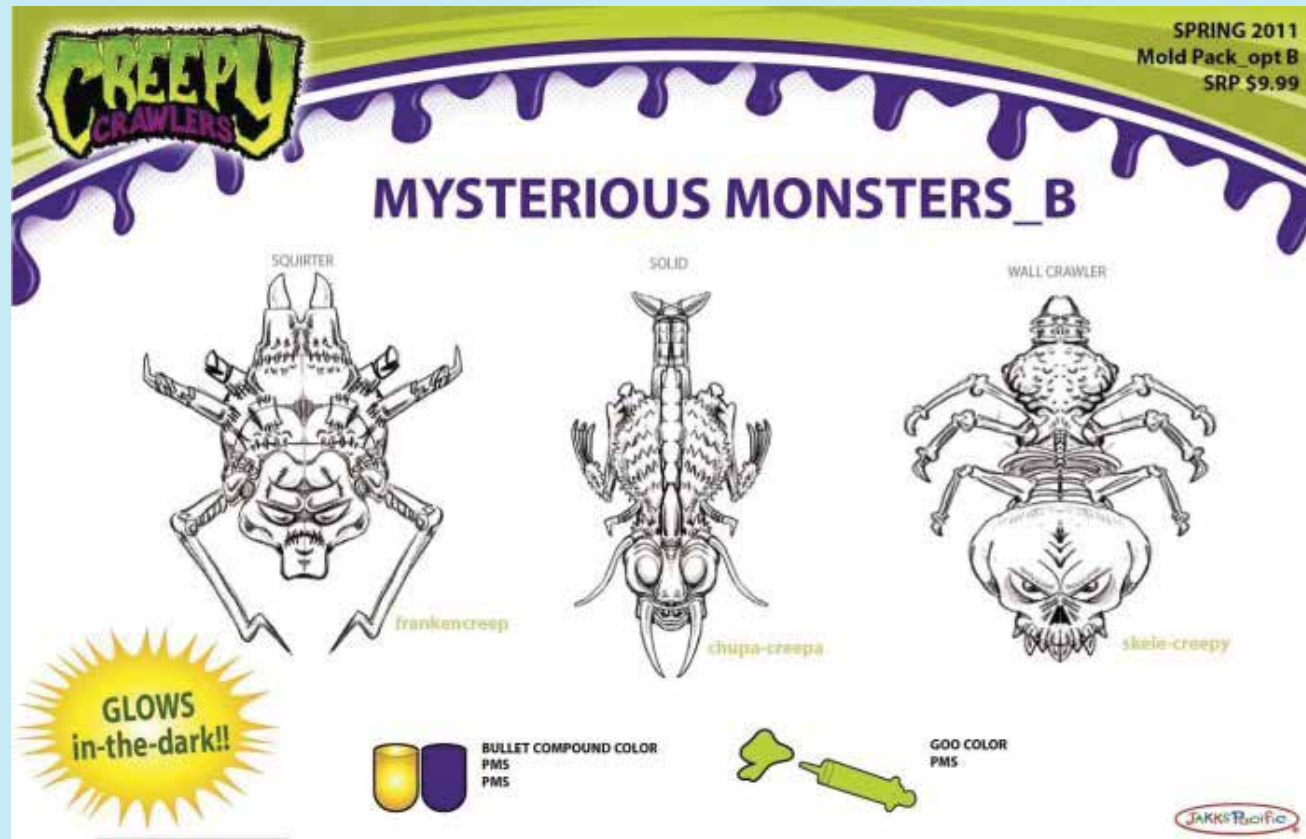

SESAME STREET **CHAT TIME** \$19.99

Let's call Cookie Monster and hear what he did today!

Hi! Today we eat 1 apple, 1 yellow banana and 1 orange. It's delicious day!

- Make Bird Calls with your pal, Big Bird! Hear about your favorite friend's days in living color on our 4 color led screen.
- People and Places
- Alphabet
- Phonics
- Numbers
- Counting
- Shapes
- Colors
- Spanish
- Manners
- Decision Making
- People and Places

Candy Cookie Pizza Party

1. Mix cookie dough.
2. Roll out dough.
3. Roll the dough flat.
4. Add toppings.
5. Bake the pizza.
6. Slice the pizza & enjoy!

I AM T-PAIN PRO TUNES CAM

WITH SIMPLE EDITING MAKE YOUR OWN AUTO TUNE VIDEOS! ADD GRAPHICS, TRANSITIONS, SF X, MUSIC LOOPS & EVEN ADD T-PAIN TO YOUR VIDEOS!

MAKE YOUR OWN CHOCOLATE EGGS SURPRISE!

1. MIX POWDER PLUS WATER INSIDE FUNNELS AND THEN FILL UP EGG!
2. REMOVABLE MOLD "FILL AND FREEZE" THEN PUT IN GIANT EGG!
3. TURN DIAL TO SPIN EGGS.
4. PUT CHOCOLATE TOP INSIDE
5. THE PRINTED FOLIO TO WRAP EGG AND GIFT TO A FRIEND!

DR. WEIRDS MAD CREATIONS! MAD LAB PLAYSET

- *Specimen jars
- *Net
- *Tweezers
- *Dissolve Bags
- *Pull Lever to pump bubbles.
- *Turn Lever to lower dissolve bag.
- *"RARE" EXTRA WEIRD OCTO PICKLE
- *Spring Launch Creatures.

Characters: EYE-CAT, FROG HOUSE, SPIDER DOG.

MAKE YOUR OWN CHOCOLATE EGGS SURPRISE!

1. MIX POWDER PLUS WATER AND MAKE A "MAGIC SHELL" DARK CHOCOLATE.
2. PUT LIQUID CHOCOLATE INSIDE FUNNELS AND FILL UP EGG!
3. SPIN CRANK TO SPIN EGG.
4. REMOVABLE MOLD "FILL AND FREEZE" THEN PUT IN GIANT EGG!
5. THE PRINTED FOLIO TO WRAP EGG AND GIFT TO A FRIEND!

GLOWIN' GROW BRAINS Clear Skullz with growing brains! BRAIN grows in water.

Characters: The Scientist, The Monster, The Monkey, The Zombie.

MADE YOUR OWN

DR. WEIRDS MAD CREATIONS! WEIRDOS INSIDE WHO WILL YOU GET? 8 \$50 to collect!

MAD LAB EXPERIMENT

"MOLD a WEIRDO!"

INCLUDING SECRET FORMULA AND 1 WEIRDO MOLD

INCLUDING MYSTERY WEIRDOS

REFERENCE: MAD SCIENTIST

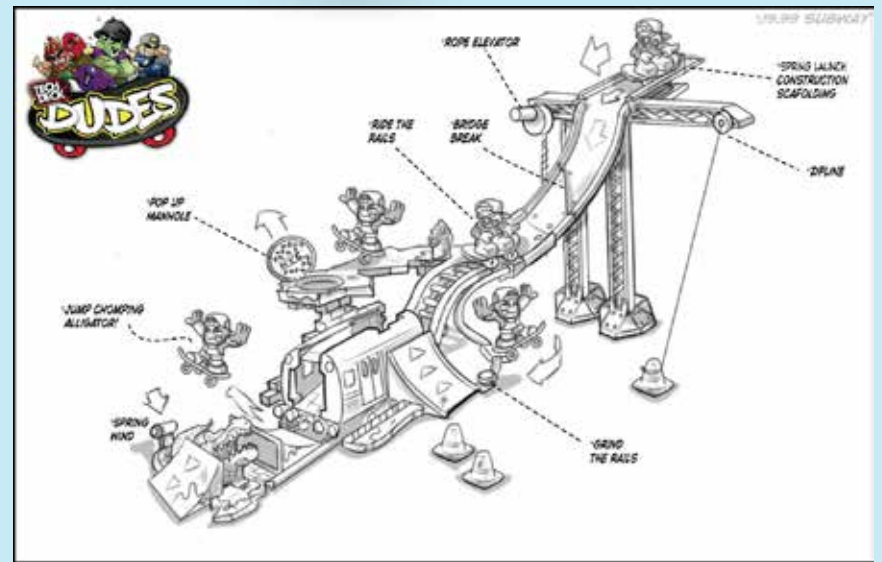
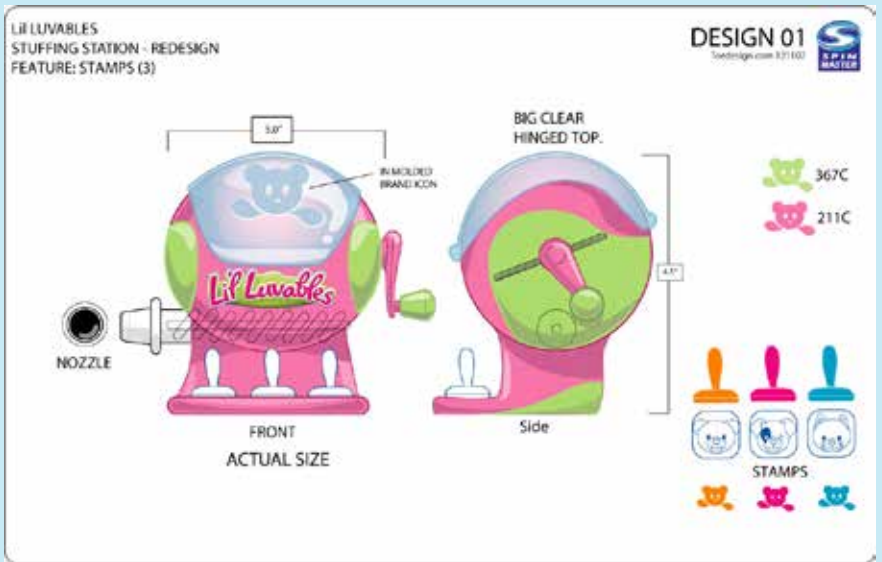
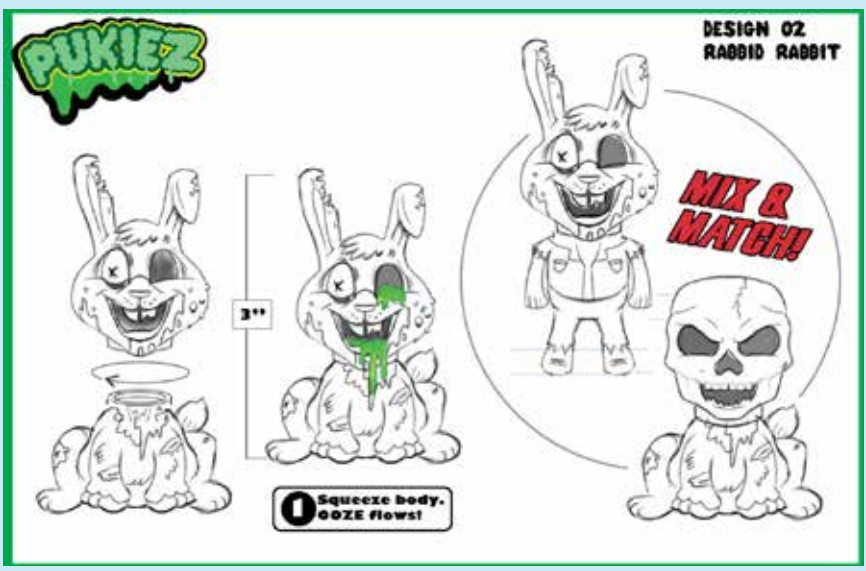
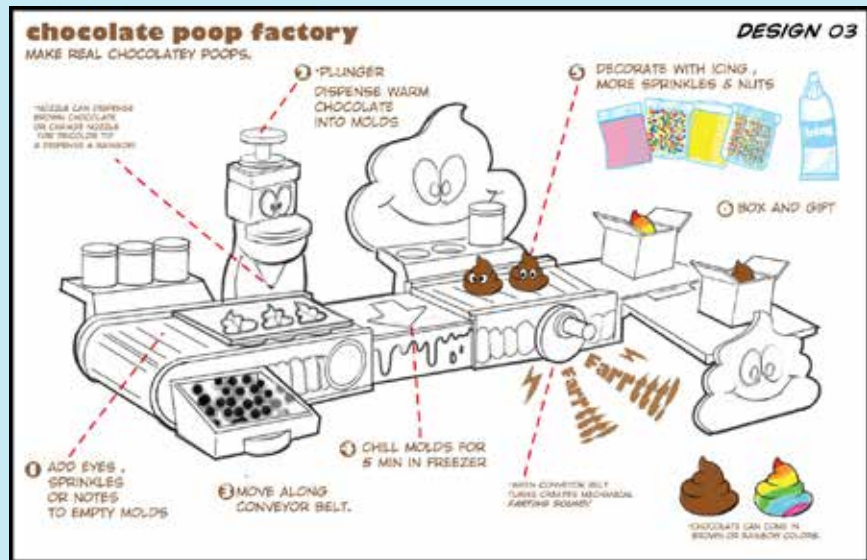



Building a better toy

Play is serious business for these students at FIT

Step into Professor Judy Ellis' office and you won't see stacks of money books and journals. Instead you'll see large shelves overflowing with toys.

All kinds of toys — big and small stuffed animals, dolls, wooden trains, metal cars, pull toys, toys that snap together, and toys that come apart. There are even tiny ones-of-a-kind toys such as Lenny the Lion-Ball, a large friendly-looking fuzzy lioness creature with a big head and big feet. And, on the walls, you'll find giant, colorful photographs of children at play.

It makes sense.

Ellis is the founder and chairwoman of the Fashion Institute of Technology's toy design program, the only such baccalaureate program in the world. And it is Ellis' philosophy about what's good for children and what makes a really great toy that is the guiding force behind the program. Invented in 1989 in a cooperative effort between the college, the Toy Manufacturers of America and United College Employees of FIT, a United Teachers affiliate.

"We distinguish between good, successful and great toys," Ellis said. "A good toy is one that reflects the play needs of a child, as well as a comprehensive knowledge of safety standards. A successful toy exhibits a keen understanding of the market. But a great toy — a really great toy — combines these vital elements and adds the creative ingenuity of innovation."

"That's what every toy maker that begins with," Ellis continued. "When you can add that and produce the success of Disney for a child, that's what it's all about."

most are only create cute, innovative stuffed toys, but the characters they design must have a personality and a story that will teach children something. For example, Lenny the Lion-Ball teaches children about tolerance by pushing out anything a child tries to hide under the hood. Students eventually write and illustrate short children's books to go with their stuffed creations.

The program is rigorous. Students complete a summer internship with a toy manufacturer or inventor group, take courses in toy safety, marketing, drawing, modeling, and hand and soft toy design, and study child psychology and development.

Students also spend time hours a week volunteering in a Head Start center to see first-hand experience with children and observe how children play. Students also work with staff and teachers at TOTS, a Bronx educational agency serving disabled children and their families, to try to design toys especially for disabled youngsters.

"They get to see first-hand how challenging a toy needs to be for a kid," Ellis said. "Designing for children is really an honor."

Getting into the toy design program at FIT, located in Manhattan's garment district and part of the State University of New York, is also no honor. About 100 people apply to the program each year and only 20 or 22 students are

accepted to the program produce what the toy industry needs, resulting in a consistent 95 percent job placement rate.

The program has worked closely with industry since its inception and is a outgrowth of a 1989 toy design contest sponsored by Mattel. "The FIT Ellis approached the Toy Manufacturers of America for help in setting up the contest and the organization is now providing her with all sort of a program for people for their industry."

With the help of Judy Piekus, a curriculum coordinator for FIT and executive vice president of the United College Employees, the program was born. "This is a good example of the union and the administration working well together," said UCE President Louis Stuller, who also represents community colleges on the NYSUT board of directors. The program serves only juniors and seniors. Applicants must have a minimum

of an associate-level degree in an art or design-related area, and display a strong talent for drawing, creativity and an appreciation for play.

Karen Therakian, 22, was a fine arts and sculpture student at FIT before she got into the toy design program. She says she was inspired by the program's focus on creating toys that teach children something. "I was really into it," she said. "I was really into it."

Gregory Morris, 20, completed the illustration program at FIT before entering toy design. Morris said he enjoys working with children. "With my art talent, this is a way to try to give what I have to offer to children," he said.

New Jersey The Star-Ledger

TUESDAY, FEBRUARY 19, 2008

All's fair in fun and games at toy expo

Show unveils the hottest items and trends



Aaron Tompkins of Union City demonstrates his talking Swear Bears, the bad boys of the stuffed bear world.

BY PETER GENOVESE
STAR-LEDGER STAFF

NEW YORK — Kids are not allowed at the country's biggest toy fair, which is probably a good thing given the grown-up nature of some of the products on display.

"This is America's number one bad bear," Aaron Tompkins of Union City said of his Swear Bears, a line of talking teddy bears that live up to their name.

Welcome to the 105th annual American International Toy Fair, a showcase and meeting place for 1,200-plus manufacturers, distributors, importers and sales agents from 94 countries.

The four-day fair, held at the Jacob K. Javits Convention Center, ends tomorrow. It is both serious trade show and informal schmooz-fest. The air is rife with gossip, rumor, trade secrets, and wheeling and dealing.



REPORTER

I COULD DO THAT

THE TOY DESIGNER

Aaron Mark, 29, gets paid to think like a child

Customer feedback

"It's fun to hear other people talk about your toy. I sometimes hang out in toy aisles. Kids will be like, 'That thing sucks,' or 'This is the coolest.' Then you start thinking, 'Man, I should have made more money on that thing!'"

seeks SWM into albinos, muscle relaxants and wrestling in mayonnaise. No freaks.

Pleasure children!

Toy inventors needed to dream up new playthings for youngsters

Do you still play with G.I. Joe? Have you kept your old Star Wars play sets? Do you find your sleep filled with visions of that luscious Strawberry Shortcake? The toy industry wants dreamers like you! Positions available for creative individuals to generate new ideas for toys, dolls and board games that are capable of separating dating parents from their money. Education at F.I.T.'s toy design department recommended. Hours flexible. Royalties reach 5 percent of total toy sales.

NEEDED: Parents who get involved



The toy molester gave Bear something to swear about

One of the funniest toys I ever did was a smoking baby. It was hilarious. Of course, nobody wanted to go there

Corporate waste

"One of the funniest toys I ever did was a smoking baby. I put a pump in a doll's head so when you stuck a cigarette in his mouth and pumped his head, he'd smoke the cigarette. It was hilarious. Of course, nobody wanted to go there. It's OK, though; most inventors will create 100 toys a year, and then sell only two or three."

Grass-roots marketing

"My newest thing is the Swear Bear. For the earliest version, I



bought these generic teddy bears with a recordable chip. They're usually sold in hospitals so mothers can put messages in there like "Get better soon!" My chips say, "What are you, a fucking pervert? You gotta touch teddy bears? Why don't you go fuck yourself!" We put them up on the Internet and sold a couple thousand really quickly."

Executive compensation

"I sold this playset to Micro Machines back in the day. From that, I had enough money to move back to New York and set up a small company. I bought a Porsche 928, but I blew the engine after three months. It was a rock 'n' roll lifestyle till I blew all the money." (AW)

Thank
you!

Aaron Tompkins
www.Toedesign.com
Toedesign@aol.com